



ALUMINIOS
AYUSO

**TARIFA DE PRECIOS PVP
PUERTAS**

**ELEVABLES
PLEGABLES
OSCILOPARALELAS**

Abril-2022

ÍNDICE

Serie Magnum 200

Modelos	3
Tarifa de Puertas, Fijos y Pilastras	4

Serie Magnum 400

Modelos	7
Tarifa de Puertas, Fijos y Pilastras	8

Serie Plegables

Modelos	11
Tarifa de Puertas, Fijos y Pilastras	12
Zócalos	13

Series Plegables RPT

Modelos	15
Tarifa de Puertas y Fijos	16

Serie Nordic60 - Osciloparalela

Modelos	17
Tarifa de Puertas y Fijos	18

Serie Nordic70 - Osciloparalela

Modelos	19
Tarifa de Puertas y Fijos	20

Serie MAGNUM 200

MODELOS

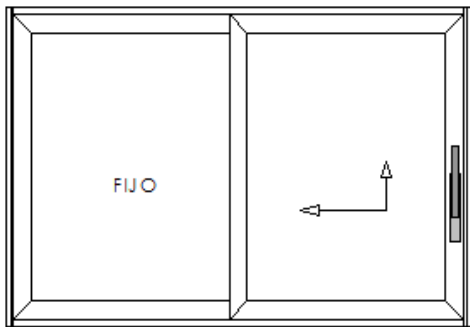

Puerta Elevable 1 Hoja + 1 Fijo
200-1

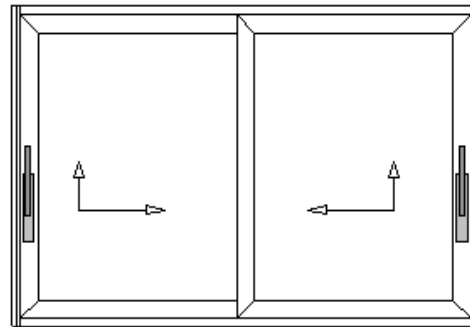

Puerta Elevable 2 Hojas
200-2

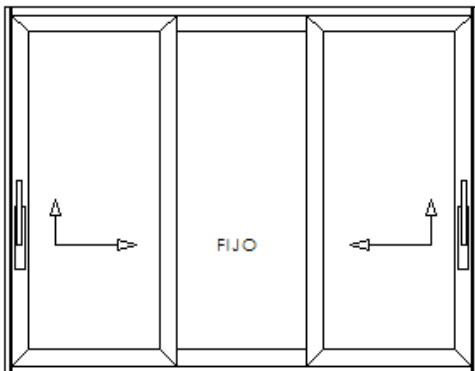

Puerta Elevable 2 Hojas + 1 Fijo
200-3

LÍMITES DE USO

Peso máximo por hoja = 200 Kg
 Alto máximo de puerta = 2700 mm
 Ancho máximo de puerta = 6400 mm
 Alto mínimo de hoja = 1175 mm
 Ancho mínimo de hoja = 650 mm

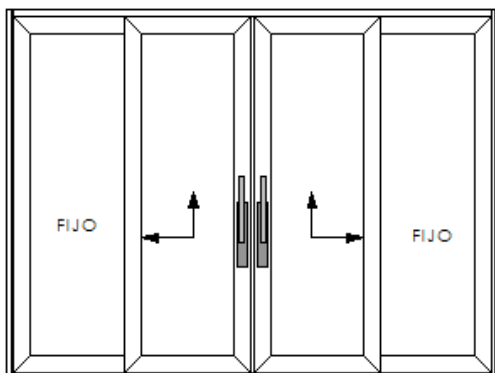

Puerta Elevable 2 Hoja + 2 Fijos
200-4

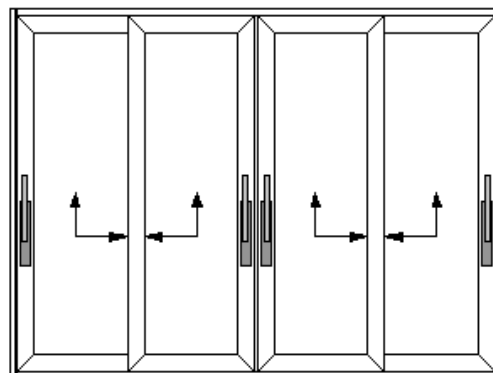

Puerta Elevable 4 Hojas
200-5

Serie MAGNUM 200

TARIFAS

MODELOS DE PUERTA							
MODELOS	LB	LM	LC	EM	PL	AC	AE
200-1	1.931	2.498	2.151	2.411	2.243	2.332	2.411
200-2	2.177	2.766	2.419	2.679	2.512	2.601	2.679
200-3	2.499	3.188	2.779	3.086	2.888	2.993	3.086
200-4	2.836	3.608	3.152	3.494	3.304	3.422	3.494
200-5	3.346	4.165	3.709	4.051	3.831	3.948	4.051

AE= Anodizados Especiales (Bronce brillo ; Inox Grata ; Oro Grata ; Negro Grata)
Medidas máximas 5.900x2.700mm

Recargos:

BICOLOR (Color más caro +Recargo) = 125
 CERRADURA = 164
 COLORES FUERA DE CARTA (LC +Recargo) = 400

FIJOS							
LARGO	LB	LM	LC	EM	PL	AC	AE
6.000	268	343	290	330	304	318	330
12.000	438	588	483	562	511	538	562
18.000	609	833	675	794	717	758	794

AE= Anodizados Especiales (Bronce brillo ; Inox Grata ; Oro Grata ; Negro Grata)

Recargos:

BICOLOR (Color más caro +Recargo) = 125

PILASTRAS							
LARGO	LB	LM	LC	EM	PL	AC	AE
6.000	116	160	130	153	138	146	153

AE= Anodizados Especiales (Bronce brillo ; Inox Grata ; Oro Grata ; Negro Grata)

Recargos:

BICOLOR (Color más caro +Recargo) = 125
 ACCESORIOS Y MANO DE OBRA (Precio X Pilastra) = 83

Serie MAGNUM 200

Tabla de Acristamientos (1)

	JUNQUILLOS				
	9686	9685	1810	1806	1807
9881 - Hoja	10,9	10,9	15,4	21,7	31,7
9885 - Fijo	10,9	10,9	15,4	21,7	31,7
9886 - Pilastra	10,9	10,9	15,4	21,7	31,7

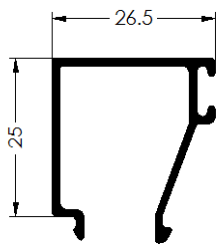
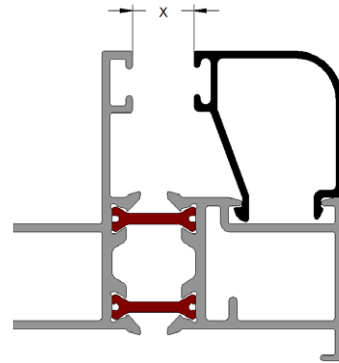

Ref. 9686
JUNQUILLO 25 mm

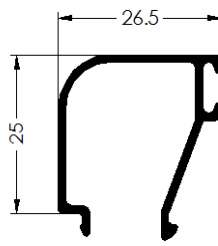

Ref. 9685
JUNQUILLO 25 mm

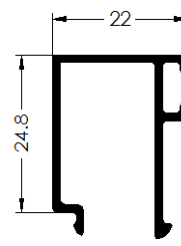

Ref. 1810
JUNQUILLO 25 mm

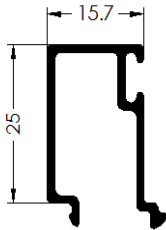

Ref. 1806
JUNQUILLO 25 mm

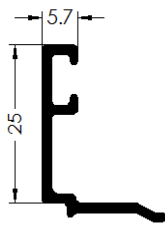

Ref. 1807
JUNQUILLO 25 mm

Serie MAGNUM 200

Tabla de Acristalamientos (2)

ESPESOR DEL ACRISTALAMIENTO																								
COMPOSICIÓN	2	3	4	5	6	7	8	9	10	11	12	13	14	15	16	17	18	19	20	21	22	23	24	25

Nota: Tabla de acristalamientos para goma exterior (0450) y goma interior (0466 o 0412)

Serie MAGNUM 400

MODELOS

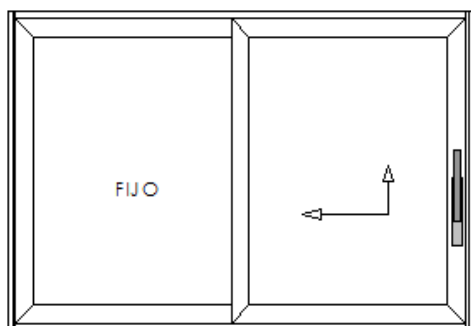

Puerta Elevable 1 Hoja + 1 Fijo
400-1

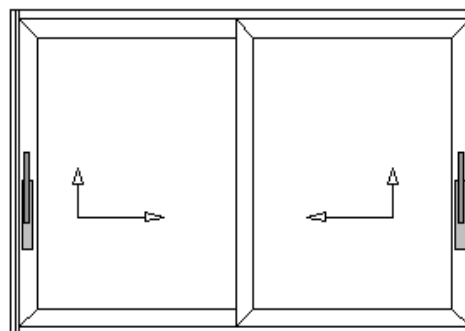

Puerta Elevable 2 Hojas
400-2

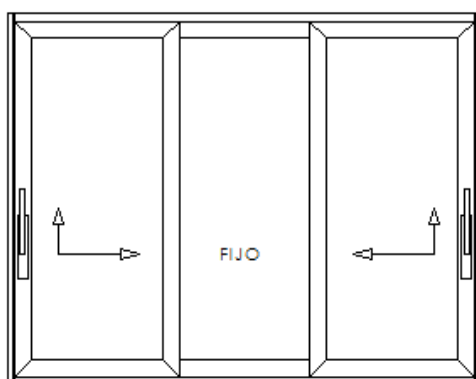

Puerta Elevable 2 Hojas + 1 Fijo
400-3

LÍMITES DE USO
Peso máximo por hoja = 300 Kg
Peso máx. por hoja con suplemento = 400 Kg
Alto máximo de puerta= 2700 mm
Ancho máximo de puerta= 7000 mm
Alto mínimo de hoja= 1175 mm
Ancho mínimo de hoja= 1370 mm

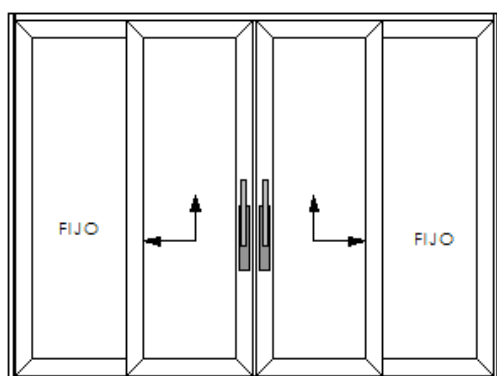

Puerta Elevable 2 Hoja + 2 Fijos
400-4

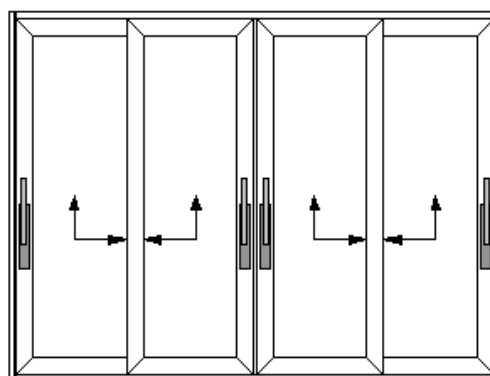

Puerta Elevable 4 Hojas
400-5

Serie MAGNUM 400

TARIFAS

MODELOS DE PUERTA							
MODELOS	LB	LM	LC	EM	PL	AC	AE
400-1	2.203	2.891	2.349	2.784	2.576	2.686	2.784
400-2	2.471	3.229	2.756	3.111	2.882	3.004	3.111
400-3	2.842	3.723	3.172	3.585	3.319	3.460	3.585
400-4	3.231	4.219	3.604	4.066	3.768	3.926	4.066
400-5	3.749	4.785	4.169	4.631	4.334	4.492	4.631

AE= Anodizados Especiales (Bronce brillo ; Inox Grata ; Oro Grata ; Negro Grata)
Medidas máximas 5.900x2.700mm

Recargos:

COMPLEMENTO 400Kg = 178

CERRADURA = 164

COLORES FUERA DE CARTA (LC +Recargo) = 400

FIJOS							
LARGO	LB	LM	LC	EM	PL	AC	AE
6.000	300	388	326	373	343	359	373
12.000	501	679	554	648	587	619	648
18.000	703	970	782	923	832	880	923

AE= Anodizados Especiales (Bronce brillo ; Inox Grata ; Oro Grata ; Negro Grata)

Recargos:

BICOLOR (Color más caro +Recargo) = 125

PILASTRAS							
LARGO	LB	LM	LC	EM	PL	AC	AE
6.000	109	152	123	145	131	138	145

AE= Anodizados Especiales (Bronce brillo ; Inox Grata ; Oro Grata ; Negro Grata)

Recargos:

BICOLOR (Color más caro +Recargo) = 125

ACCESORIOS Y MANO DE OBRA (Precio X Pilastra) = 83

Serie MAGNUM 400

Tabla de Acristalamientos (1)

	JUNQUILLOS					
	15404	9686	9685	1810	1806	1807
9681 - Hoja	16,6	28,1	28,1	32,6	38,9	48,9
9783 - Fijo	16,6	28,1	28,1	32,6	38,9	48,9
9718 - Pilastra	16,6	28,1	28,1	32,6	38,9	48,9

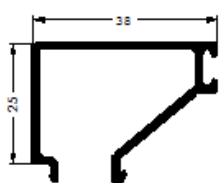
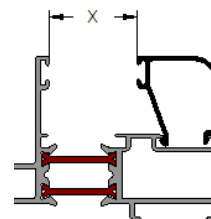

Ref. 15404
JUNQUILLO 25 mm

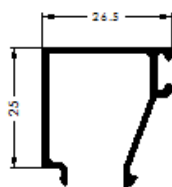

Ref. 9686
JUNQUILLO 25 mm

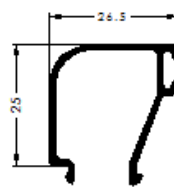

Ref. 9685
JUNQUILLO 25 mm

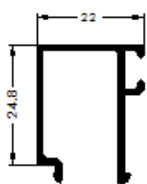

Ref. 1810
JUNQUILLO 25 mm

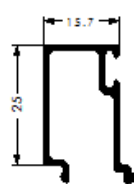

Ref. 1806
JUNQUILLO 25 mm

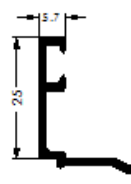

Ref. 1807
JUNQUILLO 25 mm

ESPESOR DEL ACRISTALAMIENTO																										
COMPOSICIÓN	4	5	6	7	8	9	10	11	12	13	14	15	16	17	18	19	20	21	22	23	24	25	26	27		

Serie MAGNUM 400

Tabla de Acristalamientos (2)

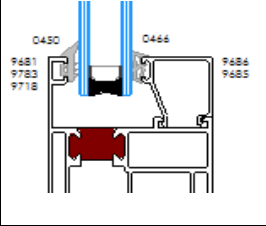
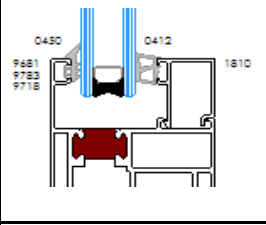
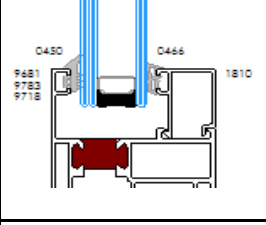
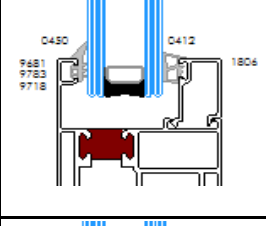
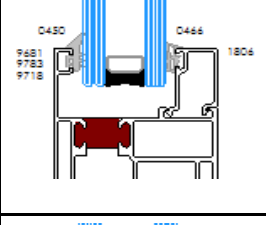
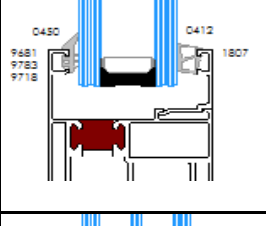
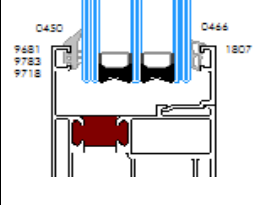
ESPESOR DEL ACRISTALAMIENTO																									
COMPOSICIÓN	18	19	20	21	22	23	24	25	26	27	28	29	30	31	32	33	34	35	36	37	38	39	40	41	
																									
																									
																									
																									
																									
																									
																									

Serie PLEGABLE MODELOS

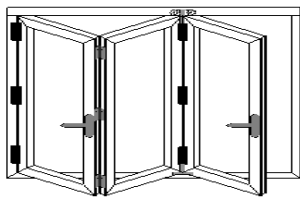

ESQUEMA 330

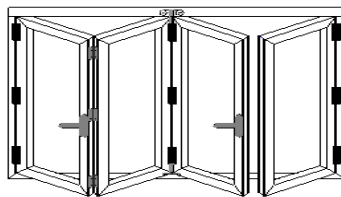

ESQUEMA 431

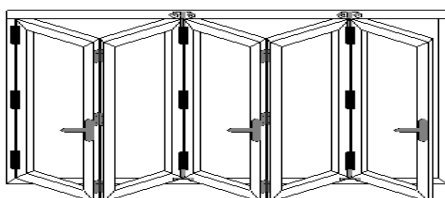

ESQUEMA 550

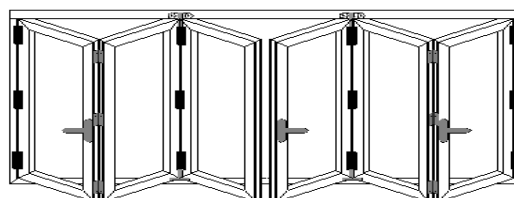

ESQUEMA 633

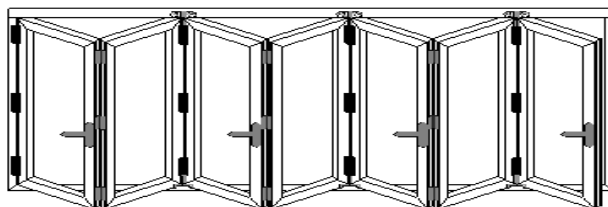

ESQUEMA 770

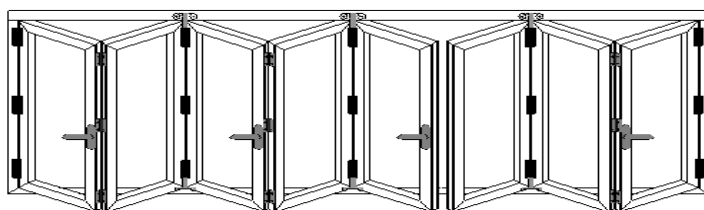

ESQUEMA 853

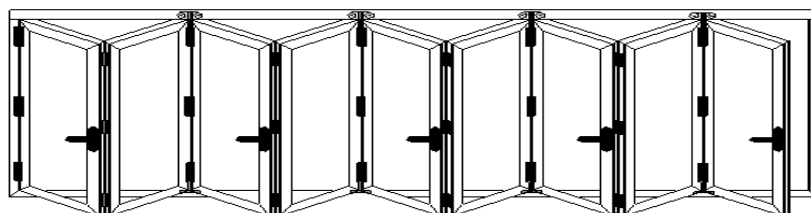

ESQUEMA 990

Serie PLEGABLE TARIFA (1)

MODELOS DE PUERTA								
ALTURA	ESQUEMAS	LB	LM	LC	EM	PL	AC	AE
hasta 2.200mm	330	1.133	1.437	1.259	1.392	1.307	1.352	1.392
	431	1.457	1.861	1.620	1.801	1.685	1.746	1.801
	550	1.737	2.216	1.932	2.145	2.007	2.080	2.145
	633	1.989	2.531	2.211	2.452	2.297	2.379	2.452
	770	2.264	2.872	2.515	2.783	2.611	2.702	2.783
	853	2.503	3.174	2.781	3.076	2.886	2.987	3.076
	990	2.784	3.521	3.092	3.414	3.207	3.317	3.414
2.201mm hasta 2.700mm	330	1.349	1.743	1.503	1.683	1.567	1.629	1.683
	431	1.561	2.015	1.739	1.946	1.812	1.883	1.946
	550	1.841	2.370	2.050	2.290	2.135	2.218	2.290
	633	2.093	2.686	2.329	2.597	2.425	2.516	2.597
	770	2.472	3.181	2.752	3.074	2.866	2.977	3.074
	853	2.608	3.328	2.900	3.222	3.014	3.124	3.222
	990	2.906	3.703	3.231	3.586	3.357	3.478	3.586

AE= Anodizados Especiales (Bronce brillo ; Inox Grata ; Oro Grata ; Negro Grata)

Recargos:

CERRADURA CON MANILLA 3 PUNTOS = 164
 CERRADURA CON MANILLA = 65
 COLORES FUERA DE CARTA (LC +Recargo) = 400

FIJOS								
MEDIDAS	ESQUEMAS	LB	LM	LC	EM	PL	AC	AE
2400x500	330	354	468	395	450	415	433	450
3300x500	431	484	650	542	623	571	599	623
4100x500	550	510	679	570	651	599	627	651
4900x500	633	535	707	598	680	627	655	680
5700x500	770	665	889	744	853	783	820	853
5700x500	853	691	917	773	881	811	848	881
5900x500	990	717	945	801	909	839	877	909
PILASTRAS								
MEDIDAS		LB	LM	LC	EM	PL	AC	AE
6.000		124	188	142	176	154	166	176

AE= Anodizados Especiales (Bronce brillo ; Inox Grata ; Oro Grata ; Negro Grata)

Recargos:

ACCESORIOS Y MANO DE OBRA (Precio X Pilastra) = 50

Serie PLEGABLE TARIFA (2)

ZOCALO PLEGABLES 3 HOJAS						
	LB	LM	LC	EM	PL	AC
100	269	369	302	352	320	337
200	290	391	325	375	343	360
300	400	545	449	521	474	499
400	421	568	472	544	497	522
500	531	721	595	690	629	661
600	553	745	619	713	653	685
700	662	897	742	859	783	823
800	683	920	765	881	806	846
900	793	1.073	889	1.027	938	985
ZOCALO PLEGABLES 4 HOJAS						
	LB	LM	LC	EM	PL	AC
100	291	388	326	372	342	358
200	398	535	446	513	470	493
300	418	558	468	535	492	515
400	522	702	585	673	616	646
500	542	725	607	695	638	668
600	646	869	724	833	762	800
700	670	895	749	858	788	825
800	773	1.039	866	996	912	957
900	794	1.061	888	1.018	934	979
ZOCALO PLEGABLES 5 HOJAS						
	LB	LM	LC	EM	PL	AC
100	325	424	362	409	379	395
200	432	572	482	550	506	530
300	455	598	508	576	532	555
400	562	746	628	716	659	690
500	669	894	748	857	787	824
600	692	919	774	883	812	850
700	799	1.067	894	1.024	940	984
800	905	1.215	1.014	1.165	1.067	1.119
900	929	1.240	1.039	1.190	1.093	1.145
ZOCALO PLEGABLES 6 HOJAS						
	LB	LM	LC	EM	PL	AC
100	359	461	399	446	416	432
200	468	612	523	590	547	570
300	578	764	646	734	677	708
400	673	898	753	862	791	829
500	798	1.066	893	1.023	939	983
600	824	1.095	922	1.052	968	1.012
700	934	1.246	1.045	1.196	1.099	1.150
800	1.044	1.397	1.168	1.340	1.229	1.288
900	1.154	1.548	1.292	1.484	1.360	1.426

Serie PLEGABLE TARIFA (3)

ZOCALO PLEGABLES 7 HOJAS						
Altura	LB	LM	LC	EM	PL	AC
100	392	498	436	483	453	469
200	505	653	563	630	587	610
300	618	807	689	778	721	751
400	731	962	816	925	855	892
500	844	1.116	943	1.073	989	1.034
600	957	1.271	1.069	1.220	1.123	1.175
700	1.069	1.425	1.196	1.368	1.257	1.316
800	1.182	1.580	1.323	1.516	1.391	1.457
900	1.295	1.734	1.449	1.663	1.525	1.598
ZOCALO PLEGABLES 8 HOJAS						
Altura	LB	LM	LC	EM	PL	AC
100	605	800	676	769	709	741
200	721	958	806	920	846	885
300	834	1.112	932	1.067	980	1.027
400	949	1.270	1.062	1.218	1.118	1.171
500	1.062	1.424	1.189	1.366	1.252	1.312
600	1.184	1.589	1.326	1.523	1.396	1.464
700	1.300	1.747	1.456	1.674	1.533	1.608
800	1.413	1.901	1.582	1.822	1.667	1.749
900	1.615	2.185	1.810	2.091	1.910	2.006
ZOCALO PLEGABLES 9 HOJAS						
Altura	LB	LM	LC	EM	PL	AC
100	639	837	713	806	746	778
200	754	994	843	957	883	922
300	876	1.159	979	1.114	1.027	1.073
400	1.079	1.442	1.207	1.384	1.270	1.330
500	1.192	1.597	1.334	1.531	1.404	1.471
600	1.329	1.778	1.487	1.705	1.565	1.639
700	1.435	1.926	1.607	1.846	1.692	1.774
800	1.548	2.080	1.734	1.994	1.826	1.915
900	1.757	2.370	1.968	2.270	2.075	2.179

Serie PLEGABLE RPT

MODELOS

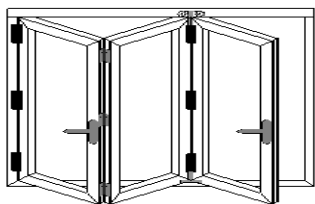

ESQUEMA 330

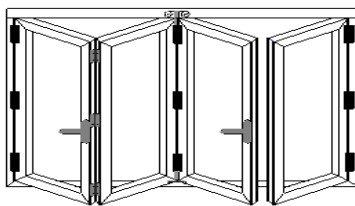

ESQUEMA 431

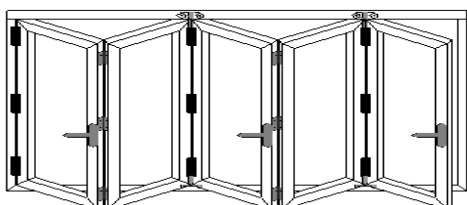

ESQUEMA 550

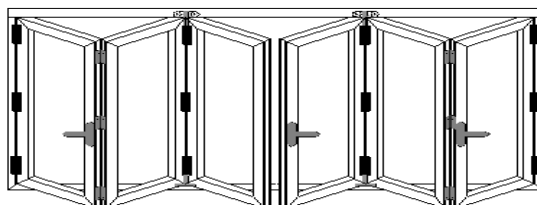

ESQUEMA 633

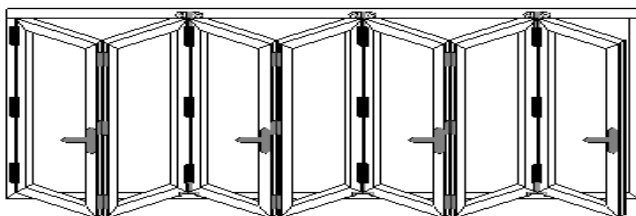

ESQUEMA 770

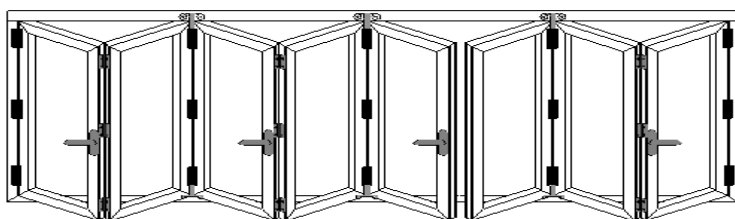

ESQUEMA 853

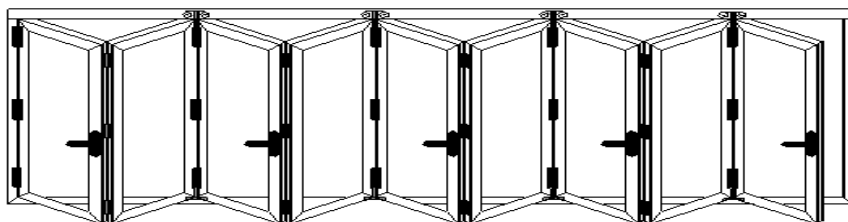

ESQUEMA 990

Serie PLEGABLE RPT TARIFAS

MODELOS DE PUERTA								
ALTURA	ESQUEMAS	LB	LM	LC	EM	PL	AC	AE
hasta 2.200mm	330	1.659	2.107	1.843	2.041	1.914	1.982	2.041
	431	2.180	2.782	2.424	2.693	2.519	2.611	2.693
	550	2.506	3.315	2.894	3.210	3.006	3.115	3.210
	633	2.813	3.734	3.257	3.615	3.384	3.507	3.615
	770	3.183	4.221	3.689	4.088	3.831	3.967	4.088
	853	3.500	4.651	4.063	4.504	4.220	4.371	4.504
	990	3.875	5.143	4.501	4.983	4.672	4.837	4.983
2.201mm hasta 2.700mm	330	2.034	2.623	2.265	2.534	2.360	2.452	2.534
	431	2.276	3.055	2.642	2.952	2.752	2.858	2.952
	550	2.680	3.589	3.112	3.470	3.239	3.362	3.470
	633	2.987	4.007	3.475	3.875	3.617	3.754	3.875
	770	3.309	4.419	3.852	4.278	4.003	4.149	4.278
	853	3.674	4.924	4.281	4.764	4.453	4.618	4.764
	990	4.067	5.445	4.739	5.269	4.927	5.109	5.269

AE= Anodizados Especiales (Bronce brillo ; Inox Grata ; Oro Grata ; Negro Grata)

Recargos:

BICOLOR (Color más caro +Recargo) =	125
CERRADURA CON MANILLA =	65
CERRADURA CON MANILLA 3 PUNTOS =	164
COLORES FUERA DE CARTA (LC +Recargo) =	400

FIJOS								
MEDIDAS	ESQUEMAS	LB	LM	LC	EM	PL	AC	AE
2400x500	330	487	644	544	609	596	596	609
3300x500	431	706	945	791	887	871	871	887
4100x500	550	732	973	819	915	900	900	915
4900x500	633	758	1.001	847	944	928	928	944
5700x500	770	1.003	1.331	1.121	1.250	1.177	1.231	1.250
5700x500	853	1.003	1.331	1.121	1.250	1.177	1.231	1.250
5900x500	990	1.029	1.359	1.149	1.278	1.205	1.259	1.278
PILASTRAS								
MEDIDAS	LB	LM	LC	EM	PL	AC	AE	
6.000	169	244	191	231	205	219	231	

AE= Anodizados Especiales (Bronce brillo ; Inox Grata ; Oro Grata ; Negro Grata)

Recargos:

ACCESORIOS Y MANO DE OBRA (Precio X Pilastra) =	50
BICOLOR (Color más caro +Recargo) =	125

Serie NORDIC60

MODELOS OSCILO-PARALELAS

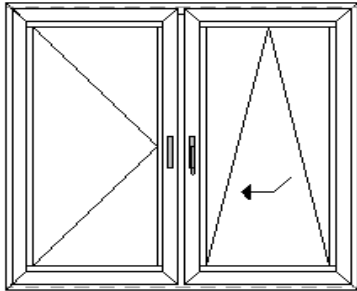

Peso Máximo = 160 Kg
(hasta 200Kg opcional)
Alto Máximo por hoja = 2.700 mm
Ancho Máximo por hoja = 1.725 mm

Modelo N60-1

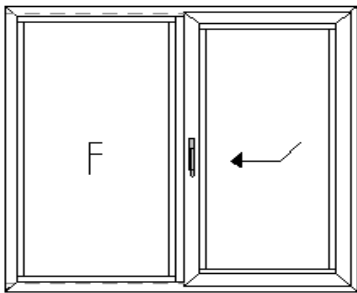

Peso Máximo = 160 Kg
(hasta 200Kg opcional)
Alto Máximo por hoja = 2.700 mm
Ancho Máximo por hoja = 2.000 mm

Modelo N60-2

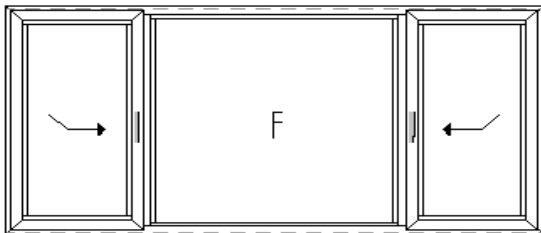

Peso Máximo = 160 Kg
(hasta 200Kg opcional)
Alto Máximo por hoja = 2.700 mm
Ancho Máximo por hoja = 2.000 mm

Modelo N60-3

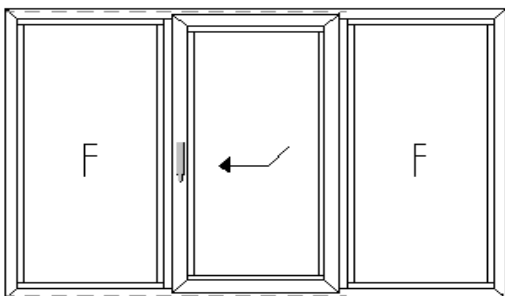

Peso Máximo = 160 Kg
(hasta 200Kg opcional)
Alto Máximo por hoja = 2.700 mm
Ancho Máximo por hoja = 2.000 mm

Modelo N60-4

Serie NORDIC60

TARIFAS OSCILO-PARALELAS

MODELOS DE PUERTA								
MEDIDAS	MODELOS	LB	LM	LC	EM	PL	AC	AE
3500x2700	N60-1	2.254	2.852	2.504	2.765	2.597	2.686	2.765
3000x2700	N60-2	1.848	2.295	2.048	2.233	2.114	2.177	2.233
6000x2700	N60-2	1.999	2.514	2.218	2.440	2.297	2.373	2.440
3000x2700	N60-3	2.817	3.416	3.113	3.341	3.194	3.272	3.341
6000x2700	N60-3	3.106	3.836	3.439	3.737	3.545	3.647	3.737
3000x2700	N60-4	1.849	2.296	2.049	2.234	2.115	2.178	2.234
6000x2700	N60-4	2.000	2.515	2.219	2.441	2.583	2.659	2.441

AE= Anodizados Especiales (Bronce brillo ; Inox Grata ; Oro Grata ; Negro Grata)

Recargos:

BICOLOR (Color más caro +Recargo) = 125
 RECARGO POR HOJA PARA 200Kg = 240
 COLORES FUERA DE CARTA (LC +Recargo) = 400

Serie NORDIC70

MODELOS OSCILO-PARALELAS

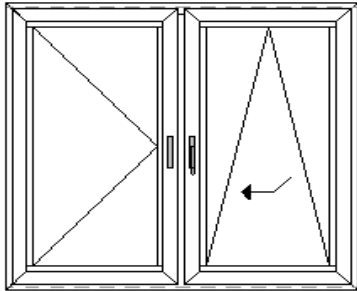

Peso Máximo = 160 Kg
(hasta 200Kg opcional)
Alto Máximo por hoja = 2.700 mm
Ancho Máximo por hoja = 1.725 mm

Modelo N70-1

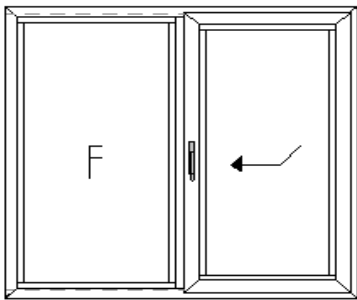

Peso Máximo = 160 Kg
(hasta 200Kg opcional)
Alto Máximo por hoja = 2.700 mm
Ancho Máximo por hoja = 2.000 mm

Modelo N70-2

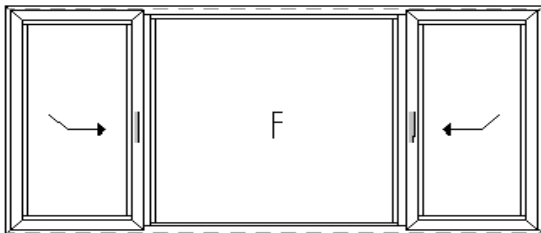

Peso Máximo = 160 Kg
(hasta 200Kg opcional)
Alto Máximo por hoja = 2.700 mm
Ancho Máximo por hoja = 2.000 mm

Modelo N70-3

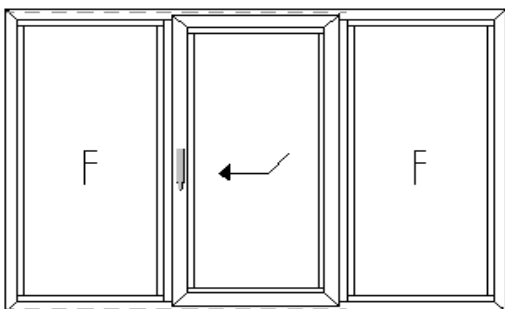

Peso Máximo = 160 Kg
(hasta 200Kg opcional)
Alto Máximo por hoja = 2.700 mm
Ancho Máximo por hoja = 2.000 mm

Modelo N70-4

Serie NORDIC70

TARIFAS OSCILO-PARALELAS

MODELOS DE PUERTA								
MEDIDAS	MODELOS	LB	LM	LC	EM	PL	AC	AE
3500x2700	N70-1	2.366	2.974	2.609	2.887	2.719	2.808	2.887
3000x2700	N70-2	1.917	2.369	2.106	2.308	2.188	2.252	2.308
6000x2700	N70-2	2.075	2.597	2.276	2.523	2.380	2.456	2.523
3000x2700	N70-3	2.975	3.574	3.266	3.502	3.361	3.435	3.502
6000x2700	N70-3	3.318	4.067	3.645	3.968	3.776	3.878	3.968
3000x2700	N70-4	2.004	2.465	2.201	2.404	2.284	2.347	2.404
6000x2700	N70-4	2.162	2.692	2.372	2.619	2.476	2.552	2.619

AE= Anodizados Especiales (Bronce brillo ; Inox Grata ; Oro Grata ; Negro Grata)

Recargos:

BICOLOR (Color más caro +Recargo) = 125
 RECARGO POR HOJA PARA 200Kg = 240
 COLORES FUERA DE CARTA (LC +Recargo) = 400